

BP6013G3 Tech Sheet

Customer: Balboa Water Group

Part Number: 56833-03 800 Incoloy 3kW

56834-03 Titanium 3kW

Custom Box Overlay

Box Overlay Part Number N/A

CE System Model For 3.0kW: BP21-BP6013G3-RCA3.0K

Software Version ID: M100_226 V43.0

Software Version: 43.0

File Name: BP6013_43.0_BP6013G3.hex

Configuration Signature: C36EF137

Eng. Project Number: 5098

Control Panels:

spaTouch™2 Any version (version 2.0 or later required for bba™2 fully integrated functionality; version 2.19 or later required for CHROMAZON3™ support)

Icon spaTouch™ Any version (version 3.36 or later required for bba™2 fully integrated functionality)

Menued spaTouch™ Any version (version 2.8 or later required for bba™2 integrated functionality)

TP900 Version 3.1 and later (Version 3.13 or later required for bba™)

TP800 Version 3.1 and later (Version 3.13 or later required for bba™; version 4.11 or later required for bba™2 integrated functionality)

TP600 Version 2.7 and later (Version 2.12 or later required for bba™/bba™2 On/Off control via menu)



Manufactured under one or more of these patents. U.S. Patents: 5332944, 5361215, 5550753, 5559720, 5,883,459, 6253227, 6282370, 6590188, 6976052, 6965815, 7030343, 7,417,834 b2, Canadian Patent: 2342614, Australian patent: 2373248 other patents both foreign and domestic applied for and pending. © Copyright 2014 Balboa Water Group.

System Revision History

Part #	EPN	Date	Originator	Changes Made
ZT000254	4697	05-01-16	BWG	BP6013 system with expander board and splitter + fused adapter.
56383 56384	4697	05-10-16	BWG	Release to production.
56383-01 56384-01	4776	10-26-16	BWG	Updated to latest software version, adding topside-intergrated bba™2 support. Released to production.
56383-02 56384-02	4890	05-31-17	BWG	Updated to latest software version, adding bba™/bba™2 On/Off support to TP600/TP400 Menus. Also corrections to wiring diagram. Released to production.
56383-03 56384-03	5098	11-26-18	BWG	Redesigned BP6013 board. + updated software to support CHROMAZONΞ™.

bba™ & bba™2 (Balboa Bluetooth Amp) connection is documented seperately.

bba™ is integrated into graphic display panels (TP800, TP900 and spaTouch™). With TP600/TP400, use the “BT” entry on the menu to toggle bba™ power On/Off.

bba™2 is integrated into graphic display panels (TP800, TP900 and spaTouch™). With TP600/TP400, use the “BT” entry on the menu to toggle bba™2 power On/Off.

Basic Functions Setup 1-9

Power Requirements:

Single Service [3 wires (line, neutral, ground)]

230VAC, 50/60Hz*, 1p, 32A, (Circuit Breaker rating = 40A max.)

Dual Service N/A

3-Service [5 wires (line 1, line 2, line 3, neutral, ground)]

230VAC line-to-neutral**, 50/60Hz*, 3p, 16A, (Circuit Breaker rating = 20A max each phase line.)

HiPot Testing Note:

Disconnect slip terminal with green wires from J11 prior to performing HiPot test. Failure to disconnect may cause a false failure of the test. Reconnect terminal to J11 after successful completion of HiPot test.

* BP systems automatically detect 50Hz vs 60Hz. However, power frequency (50Hz vs 60Hz) is just one of many differences between North American (UL) and CE power, and it is because of these other differences that different BP systems must be used for UL vs CE territories. Also, there are a few countries that use CE power but 60 Hz (such as South Korea) which need CE systems, and a few countries that use UL power but 50 Hz which need UL systems.

** 3-phase service measured line-to-line will read about 400V, but BP systems do not use it line-to-line.

IMPORTANT - Service must include a neutral wire, with a line to neutral voltage of 230VAC.

Notes regarding DIP switch A5 in 1x32A service:

By default, A5 is configured to be ON in 1x32A service, because when running 3 pumps of 12A max each, only 2 of them can be on high-speed at a time.

DIP switch A5 has no effect in any Setups other than those which have 3 pumps.

If the 3 pumps are 9A each and no blower is used, then switch A5 can definitely be turned OFF. Between 9A and 10.5A, it depends on whether a circ pump is being used and whether A/V is being used whether DIP switch A5 needs to be ON or can be turned OFF.

If the 3 pumps are 8A each plus a blower is used, then switch A5 can definitely be turned OFF. Between 8A and 9A, it depends on whether a circ pump is being used and whether A/V is being used whether DIP switch A5 needs to be ON or can be turned OFF.

Ie, you have to add up the amperages of all the 230V equipment (including the circ pump if any, the ozone if any, and A/V if any) and make sure it is no more than 32A if you want to turn DIP switch A5 OFF.

Basic Functions Setup 1-9

System Outputs:

Pump 1	230VAC	2-Speed	12A max	15-minute timer (30-minute timer for P1 Low in non-circ setups only) 1-Speed in Setups in Setups 4 - 6 This is the heater pump in Setups 7 - 9. Must deliver 20 GPM through heater
Pump 2	230VAC	1-Speed	12A max	15-minute timer
Pump 3	230VAC	1-Speed	12A max	15-minute timer Used in Setups 1, 2, 4, 5, 7 & 8
Blower	230VAC	1-Speed	4A max	15-minute timer Used in Setups 1, 3, 4, 6, 7 & 9
Circ Pump	230VAC	1-Speed	2A max	Programmable Filtration Cycles + Polling This is the heater pump in Setups 1 - 6. Must deliver 20 GPM through heater
Ozone	230VAC		.5A max	Slaved to Circ Pump in Circ Setups 1 - 6. Independent in Non-Circ Setups 7 - 9.
Spa Light	10VAC	On/Off	2A* max	240-minute timer.
A/V (Stereo)	230VAC	Hot	3A max	Always on
Heater	3.0kW @ 240VAC max			

* 2A max limit is shared by On/Off Spa Light and CHROMAZON³™.

Hardware Setup

Wiring Diagram

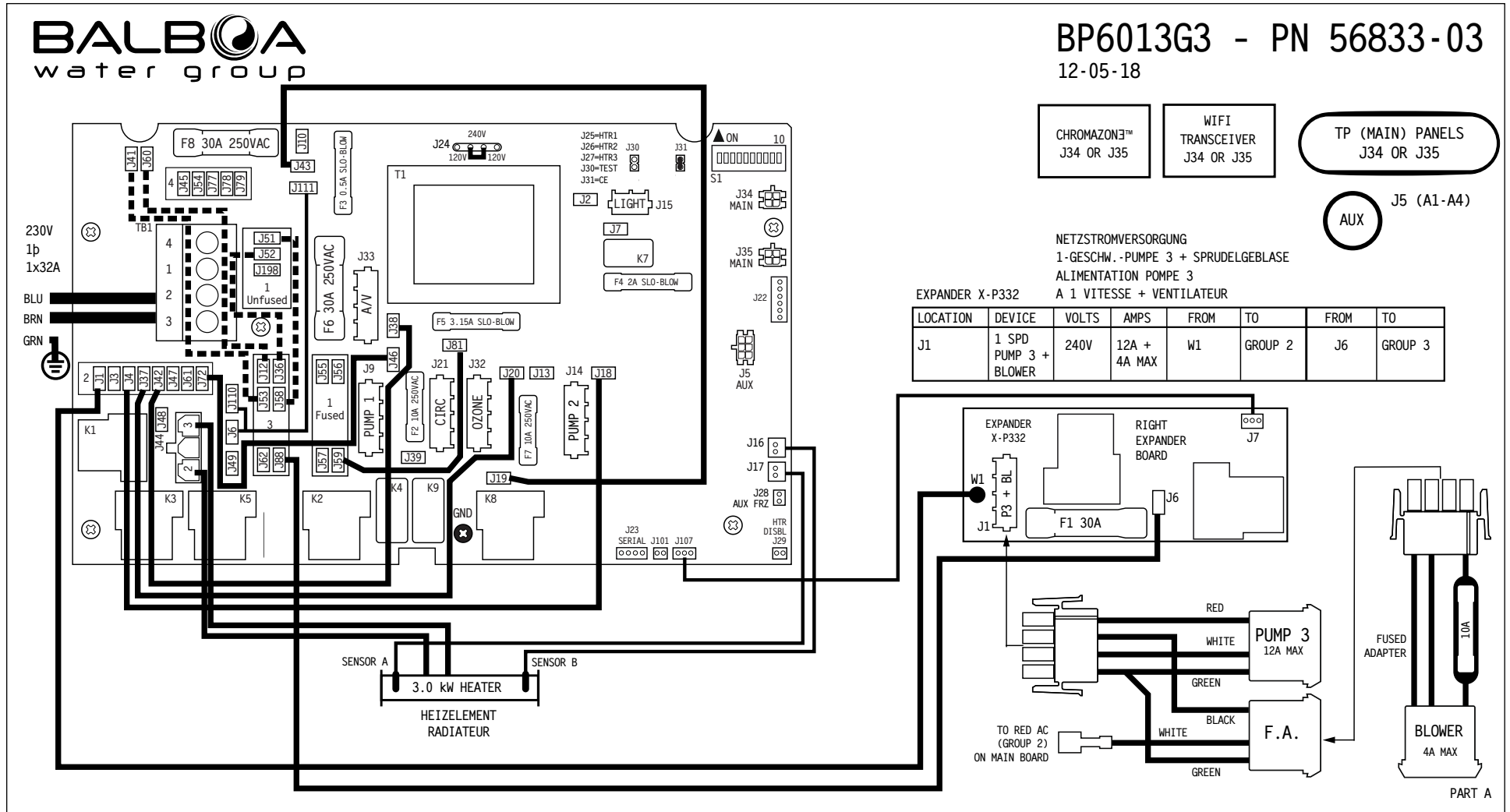

Manufactured under one or more of these patents. U.S. Patents: 5332944, 5361215, 5550753, 5559720, 5,883,459, 6253227, 6282370, 6590188, 6976052, 6965815, 7030343, 7,417,834 b2, Canadian Patent: 2342614, Australian patent: 2373248 other patents both foreign and domestic applied for and pending.

© Copyright 2014 Balboa Water Group.

BALBOA
water group

Hardware Setup

Settings

SINGLE SERVICE 230V 1p / 1x32A, THREE-SERVICE 230V 3p / 3x16A

LOCATION	DEVICE	MAX AMPS
J9	NETZSTROMVERSORGUNG 2/1-GESCHW. -PUMPE 1 ALIMENTATION POMPE 1 A 2/1 VITESSES 2/1-SPD PUMP 1	12A
J14	1-SPD PUMP 2 NETZSTROMVERSORGUNG 1-GESCHW. -PUMPE 2 ALIMENTATION POMPE 2 A 1 VITESSE	12A
J15	10V BELEUCHTUNG ECLAIRAGE BAIN HYDRO SPA LIGHT	2A* (@10V)
J21	KREISLAUF PUMPE POMPE DE CIRCULATION CIRC PUMP	2A
J32	OZONGENERATOR GENERATOROZONE OZONE GENERATOR	0.5A
J33	TV / AV	2A
J44	HEATER	3.0KW

* 2A LIMIT IS SHARED BY J15 SPA LIGHT AND CHROMAZONE™

SETUP #	CIRC PUMP	PUMP 1	PUMP 2	PUMP 3	BLOWER	TEMP SCALE
1	FILTERS + POLLING	2-SPEED	1-SPEED	1-SPEED	1-SPEED	°C
2	FILTERS + POLLING	2-SPEED	1-SPEED	1-SPEED	NONE	°C
3	FILTERS + POLLING	2-SPEED	1-SPEED	NONE	1-SPEED	°C
4	FILTERS + POLLING	1-SPEED	1-SPEED	1-SPEED	1-SPEED	°C
5	FILTERS + POLLING	1-SPEED	1-SPEED	1-SPEED	NONE	°C
6	FILTERS + POLLING	1-SPEED	1-SPEED	NONE	1-SPEED	°C
7	NONE	2-SPEED	1-SPEED	1-SPEED	1-SPEED	°C
8	NONE	2-SPEED	1-SPEED	1-SPEED	NONE	°C
9	NONE	2-SPEED	1-SPEED	NONE	1-SPEED	°C

INSTEAD OF SETUP #1, THIS SYSTEM IS CONFIGURED IN SETUP #:

FOR SUPPLY CONNECTIONS, USE CONDUCTORS SIZED ON THE BASIS OF 60°C AMPACITY BUT RATED MINIMUM OF 90°C.

USE COPPER CONDUCTORS ONLY. EMPLOYER UNIQUEMENT DES CONDUCTEURS DE CUIVRE.

TORQUE RANGE FOR MAIN TERMINAL BLOCK (TB1): 27-30 IN. LBS. (31.1-34.5 kg cm)



BALBOA
water group

BP6013G3 - PN 56833-03
12-05-18

PART B

SWITCHBANK S1 OFF	SWITCHBANK S1 ON
TEST MODE OFF	TEST MODE ON
DON'T ADD 1 HS PUMP W/HTR	ADD 1 HS PUMP WITH HEAT
DON'T ADD 2 HS PUMPS W/HTR	ADD 2 HS PUMPS WITH HEAT
DON'T ADD 4 HS PUMPS W/HTR	ADD 4 HS PUMPS WITH HEAT
SPECIAL AMPERAGE RULE A	SPECIAL AMPERAGE RULE B
STORE SETTINGS*	MEMORY RESET*
1 MIN HTR COOLDOWN (ELEC)	5 MIN HTR COOLDOWN (GAS)
NOT ASSIGNED	NOT ASSIGNED
NOT ASSIGNED	NOT ASSIGNED
NOT ASSIGNED	NOT ASSIGNED

*SWITCH # 6 SHOULD BE SET TO OFF UPON FINAL INSTALLATION.

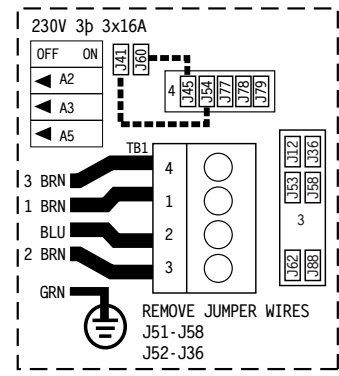

Manufactured under one or more of these patents. U.S. Patents: 5332944, 5361215, 5550753, 5559720, 5,883,459, 6253227, 6282370, 6590188, 6976052, 6965815, 7030343, 7,417,834 b2, Canadian Patent: 2342614, Australian patent: 2373248 other patents both foreign and domestic applied for and pending. © Copyright 2014 Balboa Water Group.



Setup Reference Table

Setup #	Circ Pump	Pump 1	Pump 2	Pump 3	Blower	Temp Scale
1	Programmable Filtration + Polling	2-Speed	1-Speed	1-Speed	1-Speed	°C
2	Programmable Filtration + Polling	2-Speed	1-Speed	1-Speed	None	°C
3	Programmable Filtration + Polling	2-Speed	1-Speed	None	1-Speed	°C
4	Programmable Filtration + Polling	1-Speed	1-Speed	1-Speed	1-Speed	°C
5	Programmable Filtration + Polling	1-Speed	1-Speed	1-Speed	None	°C
6	Programmable Filtration + Polling	1-Speed	1-Speed	None	1-Speed	°C
7	None	2-Speed	1-Speed	1-Speed	1-Speed	°C
8	None	2-Speed	1-Speed	1-Speed	None	°C
9	None	2-Speed	1-Speed	None	1-Speed	°C

**System (and any replacement board)
is shipped in Setup 1**

Changing Software Setups with spaTouch™ Icon-Driven Panels

Test Menu Access (S1, Switch 1 ON) *Service Technician ONLY.*

DANGER! HIGH VOLTAGE WILL BE ACCESSIBLE! SERVICE TECHNICIAN ONLY!

While the system is running, move DIP Switch 1 (on S1 on the Main circuit board) to ON. The system will enter Test Mode. Moving DIP Switch 1 to OFF will exit Test Mode.

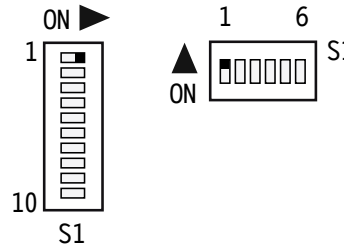

The example screens shown here are from the spaTouch 1 Icon-Driven Panel, but the screens on the spaTouch 2 Panel are similar. The main difference is that the spaTouch 2 display is wider.

To Change Software Setups:

While in Test Mode, press the indicated icons to move from screen to screen.

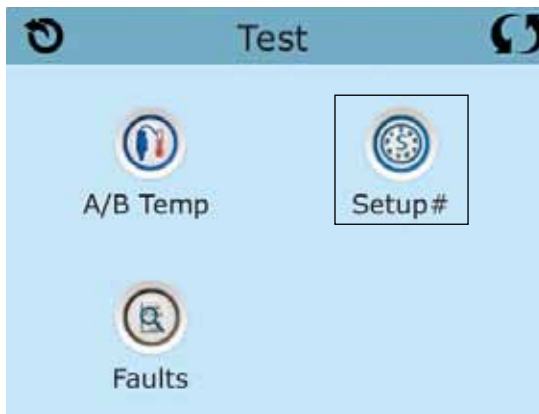
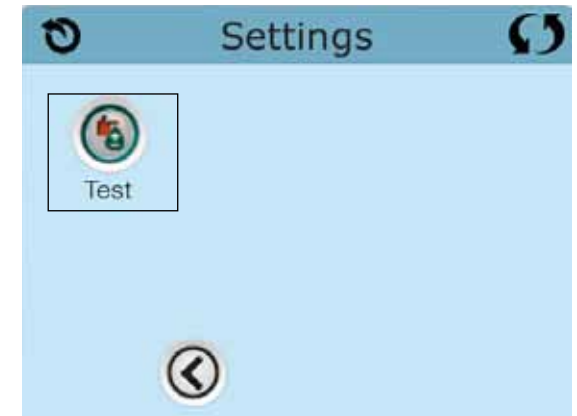

Once on the Setup Selection screen, press the Up or Down icon to select the desired Setup Number, then press the Check Mark icon to confirm and to have the spa restart.

After the system restarts, you may see a message that "The settings have been reset"; this is normal after changing Setups with DIP Switch 6 in the OFF position. Press "Clear" to dismiss this message.

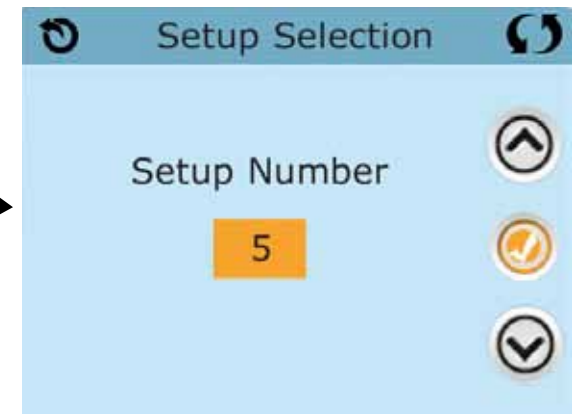

Manufactured under one or more of these patents. U.S. Patents: 5332944, 5361215, 5550753, 5559720, 5,883,459, 6253227, 6282370, 6590188, 6976052, 6965815, 7030343, 7,417,834 b2, Canadian Patent: 2342614, Australian patent: 2373248 other patents both foreign and domestic applied for and pending. © Copyright 2014 Balboa Water Group.

Changing Software Setups with TP800 / TP900 / spaTouch™ Menued Panel

Test Menu Access (S1, Switch 1 ON) *Service Technician ONLY.*

DANGER! HIGH VOLTAGE WILL BE ACCESSIBLE! SERVICE TECHNICIAN ONLY!

While the system is running, move DIP Switch 1 (on S1 on the Main circuit board) to ON.
The system will enter Test Mode.
Moving DIP Switch 1 to OFF will exit Test Mode.

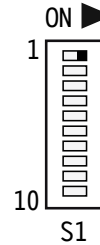

Software Setups

Under the TEST Menu, the Setup screen will allow changing the Setup from 1 to any number established by the Manufacturer.
Changing the Setup may require wiring changes as well.

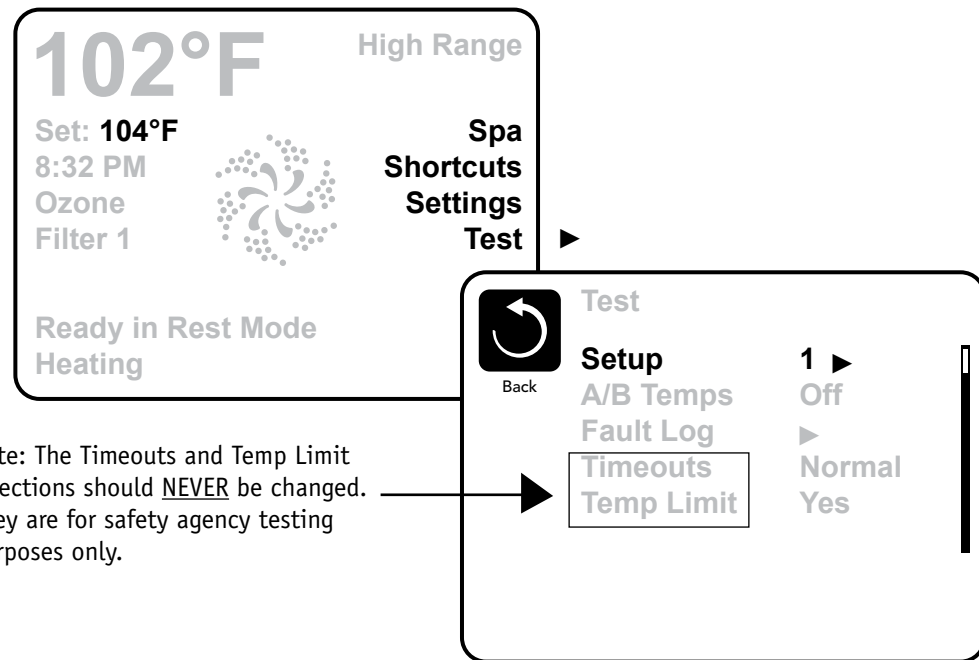

Note: The Timeouts and Temp Limit selections should NEVER be changed. They are for safety agency testing purposes only.

Changing Software Setups with TP600 / TP400

Test Menu Access (S1, Switch 1 ON) *Service Technician ONLY.*

DANGER! HIGH VOLTAGE WILL BE ACCESSIBLE! SERVICE TECHNICIAN ONLY!

While the system is running, move DIP Switch 1 (on S1 on the Main circuit board) to ON. The system will enter Test Mode. Moving DIP Switch 1 to OFF will exit Test Mode.

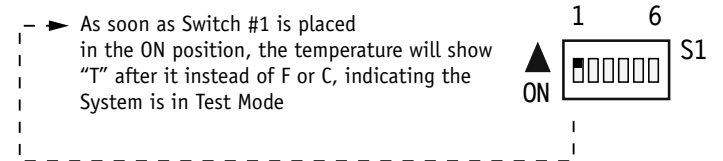

Software Setups

Under the TEST Menu, the Setup screen will allow changing the Setup from 1 to any number established by the Manufacturer. Changing the Setup may require wiring changes as well.

You will have 1 minute to complete the setup change after you manually exit Priming Mode. (Once familiar with the process, the Setup change should take less than 15 seconds.)



When the panel displays RUN PMPS PURG AIR, press any Temperature button ONCE to exit Priming Mode. You should see "---T" where the T indicates the system is in Test Mode.

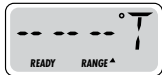

Continued on Next Page.

Changing Software Setups with TP600 / TP400 Continued

Again, **You will have 1 minute** to complete the setup change after you manually exit Priming Mode.

Immediately after exiting Priming Mode, press this sequence of buttons: Warm*, Light, Warm, Warm, Warm, Warm. Continue to press Warm until the display shows the Setup Number (S-01, S-02, etc.) you want to switch to. When the correct setup number is showing, press Light once, and the system will reset, using the newly-selected Setup from that point on.

Move DIP Switch 1 to the OFF position to take the spa out of Test Mode. °F or °C will replace °T.

Using a permanent marker, write the Setup number on the Setup label mounted inside the system lid (right). This is very important to any service person in the future who may need to replace a circuit board or system and needs to change the Setup on a replacement part while in the field.

NOTE: Changing the Setup may require wiring changes as well - refer to the wiring diagram or wiring diagram addendum.

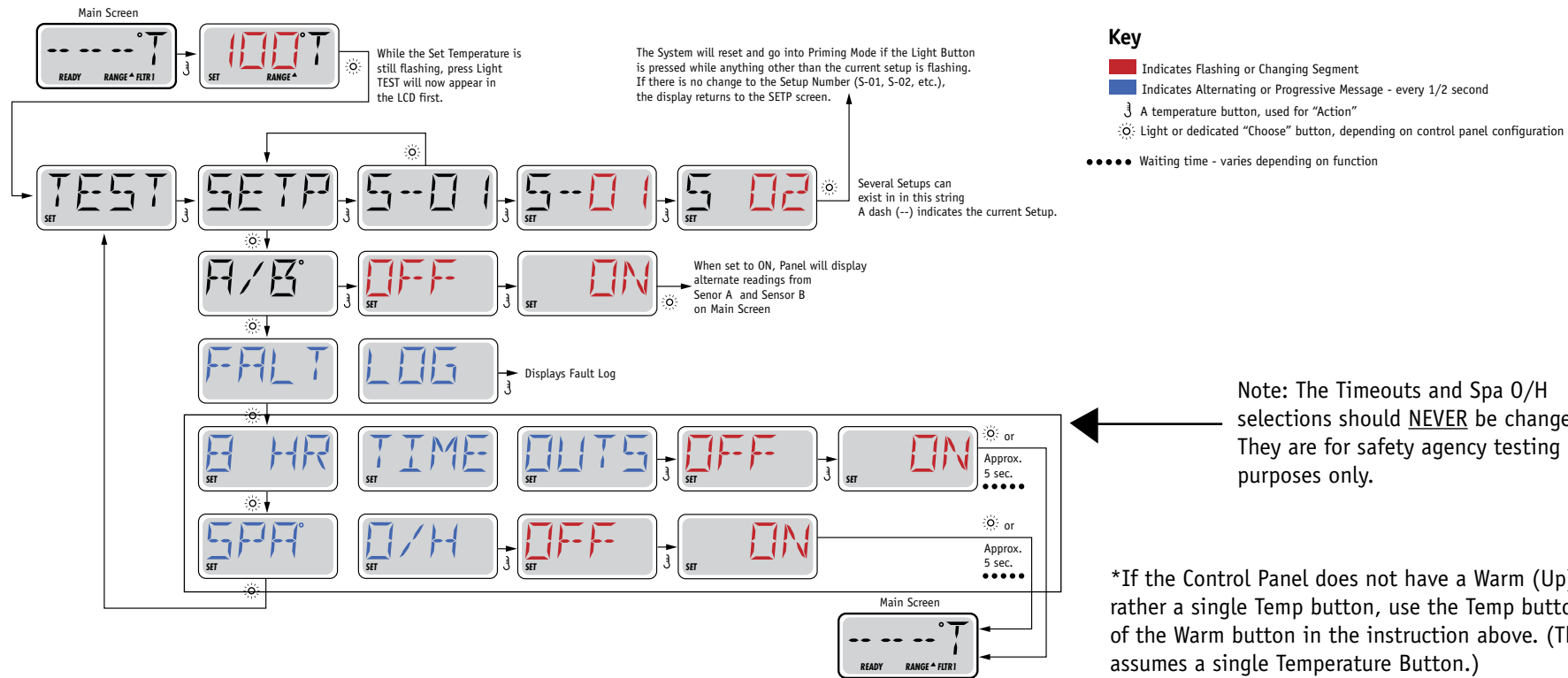
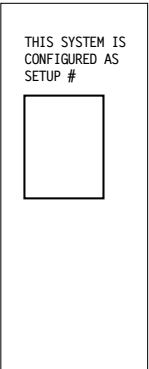

Manufactured under one or more of these patents. U.S. Patents: 5332944, 5361215, 5550753, 5559720, 5,883,459, 6253227, 6282370, 6590188, 6976052, 6965815, 7030343, 7,417,834 b2, Canadian Patent: 2342614, Australian patent: 2373248 other patents both foreign and domestic applied for and pending. © Copyright 2014 Balboa Water Group.



Equipment Expansion

Expansion Features

Control Connection

	Default	Fuse
Relay 1 (J101)	Undefined	None
Relay 7/8 (J107)	See below	30A
	1-speed Pump 3 + 1-speed Blower (using splitter +fused adapter)	

DIP Switch Functions

Fixed-function DIP Switches

- | | |
|----|--|
| A1 | Test Mode (normally Off). |
| A2 | In "ON" position, add one high-speed pump (or blower) with Heater. |
| A3 | In "ON" position, add two high-speed pumps (or 1 HS Pump and Blower) with Heater. |
| A4 | In "ON" position, add four high-speed pumps (or 3 HS Pumps and Blower) with Heater. |
| A5 | In "ON" position, enables Special Amperage Rule B. See Special Features section under Configuration Options for functionality with your system.
In "OFF" position, enables Special Amperage Rule A. |
| A6 | Persistent memory reset (Used when the spa is powering up to restore factory settings as determined by software configuration). |

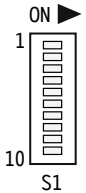

A2, A3, and A4 work in combination to determine the number of high-speed devices and blowers that can run before the heat is disabled. i.e. A2 and A3 in the ON position and A4 in the OFF position will allow the heater to operate with up to 3 high-speed pumps (or two HS Pumps and Blower) running at the same time. Heat is disabled when the fourth high-speed pump or blower is turned on.



Note: A2/A3/A4 all off = No heat with any high-speed pump or blower.

Assignable DIP Switches

- | | |
|----|---|
| A7 | In "ON" position, enables a 5-minute cooldown for some gas heaters (Cooling Time B).
In "OFF" position, enables a 1-minute cooldown for electric heaters (Cooling Time A). |
|----|---|

Undesignated switches are not assigned a function.

Jumper Definitions

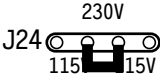
J109	Not present on BP6013 board.	
J91	Not present on BP6013 board.	
J30	Do Not Use	
J31	Jumper on 1 pin with 2.0kW or smaller heater Jumper on 2 pins with a 3.0kW or higher heater	J31 
J29	Heater Disable Switch Connection. If J29 is shorted by any means, the heater will not run until J29 is no longer shorted. If J29 is shorted during power-up “J29” will appear on the panel. The message can be dismissed with a button press, and is the only control panel notification of J29 being shorted. No message is displayed if J29 is shorted after power-up, but the heater will not run until J29 is no longer shorted. J29 expects a switch closure (not a voltage) as the command signal. In some areas, a local power company may offer discounts based on voluntary “power shedding” devices that may be installed in conjunction with the spa.	J29 
J25, J26, J27	Not present on BP6013 board.	
J24	Jumper on center two pins (230V) when heater is running at 240V. Two Jumpers installed; one on left 2 pins and one on right 2 pins (115V) when heater is running at 120V.	

Warning!

Setting DIP switches or jumpers incorrectly may cause abnormal system behavior and/or damage to system components. Refer to Switchbank illustration on Wiring Configuration page for correct settings for this system. Contact Balboa if you require additional configuration pages added to this tech sheet.

Replacement Parts

PCBA:

Main PCBA: 59145
Expander PCBA: 59097

HEATER(s):

Plug + Click Heater Kit: 58300 3.0kW 800 Inc
58302 3.0kW Titanium
Temp Sensor Kit: 53605

CABLES:

25681 (fused adapter for Blower)
25859 (splitter)

FUSES:

Part Number	Amperage	Location
30136	30A	F6, F8, F1 (Expander)
26307	2A SLO	F4
26905	0.5A SLO	F3
30122	10A	F2, F7
26976	3.15A SLO	F5

BP6013 Configuration Options

General Features

Feature	Default	
Pump 1 in Filter Cycle (Circ Only)	No	
Pump 1 Low Timer	30 Minutes	Applies in non-circ Setups (configurations) only
General Pump Timer	15 Minutes	Applies to all pumps, except Pump 1 low in Non-Circ Setups
Blower Timer	15 Minutes	
Mister Timer	15 Minutes	
Light Timer	240 Minutes	
Circ (when enabled)	Programmable + Polling	
Cleanup Cycle	<i>30 Minutes</i>	
Cleanup as Preference setting	<i>Yes</i>	
Ozone	With Heater Pump*	
Ozone Suppression	OFF	
Pump Purge	60 Seconds	
Blower Purge	30 Seconds	
Mister Purge	5 Seconds	
Purge Type	Serial - Pumps at lowest speed	

* The heater Pump can be either a Circ Pump or Pump 1 Low.

BP6013 Configuration Options

Temperature Features

Feature	Default
Temperature Display	°C

All temperatures must be specified in °F. The system converts °F to °C dynamically. If Celsius is required for default settings, choose a desired °C value that (after rounding) corresponds to a Fahrenheit value.

°C	4	5	6	7	8	9	10	11	12	13	14	15	16	17	18	19	20	21	22
°F	39	41	43	45	46	48	50	52	54	55	57	59	61	63	64	66	68	70	72
°C	23	24	25	26	27	28	29	30	31	32	33	34	35	36	37	38	39	40	
°F	73	75	77	79	81	82	84	86	88	90	91	93	95	97	99	100	102	104	

Hi-Range Min. Set Temp	80°F
Hi-Range Max. Set Temp	104°F
Hi-Range Default Temp*	100°F
Lo-Range Min. Set Temp	50°F
Lo-Range Max. Set Temp	99°F
Lo-Range Default Temp*	70°F
Freeze Threshold	44°F
Freeze Type	Rotating - Pumps at Lowest Speed
Temp Lock Type	Temp + Settings

**May be changed by end-user (if enabled)*

Manufactured under one or more of these patents. U.S. Patents: 5332944, 5361215, 5550753, 5559720, 5,883,459, 6253227, 6282370, 6590188, 6976052, 6965815, 7030343, 7,417,834 b2, Canadian Patent: 2342614, Australian patent: 2373248 other patents both foreign and domestic applied for and pending. © Copyright 2014 Balboa Water Group.

BP6013 Configuration Options

Time Features

Feature	Default
Time Format*	24 Hour
Filter 1 Start Hour*	20:00 (8:00 PM)
Filter 1 Duration*	2 Hours
Filter Cycle 2 Default*	OFF
Filter 2 Start Hour*	08:00 (8:00 AM)
Filter 2 Duration*	15 Minutes
Light Cycle	Disabled
Light Cycle Default*	OFF
Light Cycle Start Hour*	21:00 (9:00 PM)
Light Cycle Duration*	15 Minutes
Cooling Time A	1 Minute
Cooling Time B	5 Minutes

**May be changed by end-user (if enabled)*

Manufactured under one or more of these patents. U.S. Patents: 5332944, 5361215, 5550753, 5559720, 5,883,459, 6253227, 6282370, 6590188, 6976052, 6965815, 7030343, 7,417,834 b2, Canadian Patent: 2342614, Australian patent: 2373248 other patents both foreign and domestic applied for and pending. © Copyright 2014 Balboa Water Group.

BP6013 Configuration Options

Reminder Features

Feature	Default
Reminders Shown*	<i>Yes</i>
Check pH	<i>OFF</i>
Check Sanitizer	<i>OFF</i>
Clean Filter	30 Days
Test GFCI	<i>65 Days</i>
Drain Water	<i>100 Days</i>
Change Cartridge	OFF
Clean Cover	<i>OFF</i>
Treat Wood	<i>OFF</i>
Change Filter	365 Days

**May be changed by end-user (if enabled)*

Manufactured under one or more of these patents. U.S. Patents: 5332944, 5361215, 5550753, 5559720, 5,883,459, 6253227, 6282370, 6590188, 6976052, 6965815, 7030343, 7,417,834 b2, Canadian Patent: 2342614, Australian patent: 2373248 other patents both foreign and domestic applied for and pending. © Copyright 2014 Balboa Water Group.

BP6013 Configuration Options

Special Features

Feature	Default
Special Amperage Rule A	No Limitation
Special Amperage Rule B	2 High Speed Pump Maximum
Drain Mode	Disabled
Demo Mode	Disabled
GFCI Trip	Not Applicable for CE Models
Ozone Slaved to Heater Pump	<i>Yes in circ setups</i> <i>No in non-circ setups</i>
Dual Voltage Heater	Always Input Voltage
Safety Suction	Disabled

TP900 Panel Configuration

Button Layout Table

Feature #	Setups 1 & 4	Setups 2 & 5	Setups 3 & 6	Setup 7	Setup 8	Setup 9
A1	N/A	N/A	N/A	N/A	N/A	N/A
A2	Jets 1	Jets 1	Jets 1	Jets 1	Jets 1	Jets 1
A3	Jets 2	Jets 2	Jets 2	Jets 2	Jets 2	Jets 2
A4	Jets 3	Jets 3	Blower	Jets 3	Jets 3	Blower
A5	Blower	Light 1	Light 1	Blower	Light 1	Light 1
A6	Light 1	Invert	Invert	Light 1	Invert	Invert
A7	Invert	(Circ Icon)	(Circ Icon)	Invert	Undefined	Undefined
A8	(Circ Icon)	Undefined	Undefined	Undefined	Undefined	Undefined
A9	Undefined	Undefined	Undefined	Undefined	Undefined	Undefined
A10	Undefined	Undefined	Undefined	Undefined	Undefined	Undefined
A11	N/A	N/A	N/A	N/A	N/A	N/A
A12	N/A	N/A	N/A	N/A	N/A	N/A
A13	Jets 1	Jets 1	Jets 1	Jets 1	Jets 1	Jets 1
A14	Jets 2	Jets 2	Jets 2	Jets 2	Jets 2	Jets 2
A15	Jets 3	Jets 3	Blower	Jets 3	Jets 3	Blower
A16	Light 1	Light 1	Light 1	Light 1	Light 1	Light 1

A Circ Icon will appear when a Circ Pump is configured.

TP900 Panel Configuration

Button #
1
2
3
4
5
6
7
8
9
10
11
12
13
14
15
16

Spa Screen

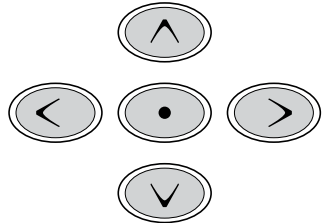
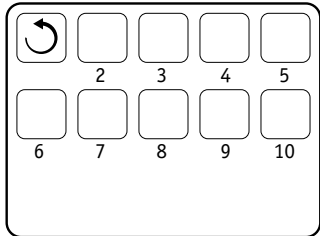

Shortcuts Screen

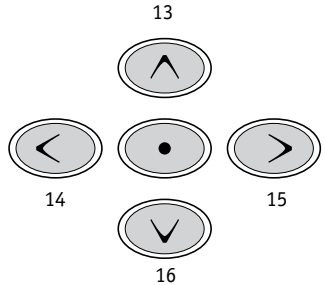
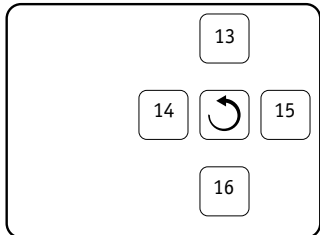

Manufactured under one or more of these patents. U.S. Patents: 5332944, 5361215, 5550753, 5559720, 5,883,459, 6253227, 6282370, 6590188, 6976052, 6965815, 7030343, 7,417,834 b2, Canadian Patent: 2342614, Australian patent: 2373248 other patents both foreign and domestic applied for and pending. © Copyright 2014 Balboa Water Group.

TP800 Panel Configuration

Button Layout Table

Feature #	Setups 1 & 4	Setups 2 & 5	Setups 3 & 6	Setup 7	Setup 8	Setup 9
A1	N/A	N/A	N/A	N/A	N/A	N/A
A2	Jets 1	Jets 1	Jets 1	Jets 1	Jets 1	Jets 1
A3	Jets 2	Jets 2	Jets 2	Jets 2	Jets 2	Jets 2
A4	Jets 3	Jets 3	Blower	Jets 3	Jets 3	Blower
A5	Blower	Light 1	Light 1	Blower	Light 1	Light 1
A6	Light 1	Invert	Invert	Light 1	Invert	Invert
A7	Invert	(Circ Icon)	(Circ Icon)	Invert	Undefined	Undefined
A8	(Circ Icon)	Undefined	Undefined	Undefined	Undefined	Undefined
A9	Undefined	Undefined	Undefined	Undefined	Undefined	Undefined
A10	Undefined	Undefined	Undefined	Undefined	Undefined	Undefined
A11	N/A	N/A	N/A	N/A	N/A	N/A
A12	N/A	N/A	N/A	N/A	N/A	N/A
A13	Undefined	Undefined	Undefined	Undefined	Undefined	Undefined
A14	Undefined	Undefined	Undefined	Undefined	Undefined	Undefined
A15	Undefined	Undefined	Undefined	Undefined	Undefined	Undefined
A16	Undefined	Undefined	Undefined	Undefined	Undefined	Undefined
B1	Jets 1	Jets 1	Jets 1	Jets 1	Jets 1	Jets 1
B2	Jets 2	Jets 2	Jets 2	Jets 2	Jets 2	Jets 2
B3	Jets 3	Jets 3	Blower	Jets 3	Jets 3	Blower
B4	Light 1	Light 1	Light 1	Light 1	Light 1	Light 1

TP800 Panel Configuration

Spa Screen

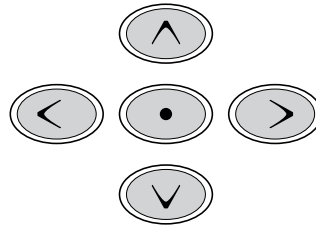
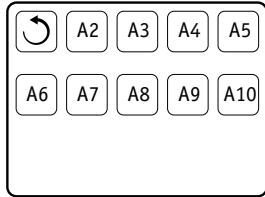
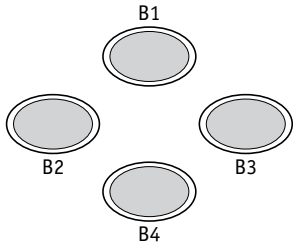

Note: Button B2 is ALWAYS unused on TP800 when used with this sytsem. A custom overlay will be required.

Shortcuts Screen

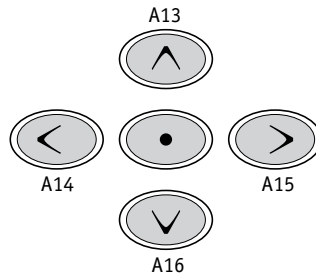
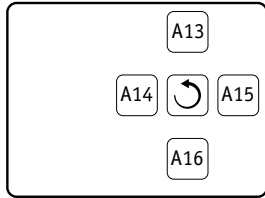
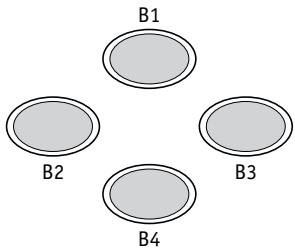

Note: Buttons 11 and 12 are not used in this configuration.

Button 1 is fixed.

TP600 Panel Configuration

Button Layout Table

Button #	Setups 1, 4 & 7	Setups 2, 5 & 8	Setups 3, 6 & 9
1	Jets 1	Jets 1	Jets 1
2	Jets 2	Jets 2	Jets 2
3	Jets 3	Jets 3	Blower
4	Temperature	Up	Up
5	Light 1	Light 1	Light 1
6	Blower	Down	Down
LED 1	Jets 1	Jets 1	Jets 1
LED 2	Jets 2	Jets 2	Jets 2
LED 3	Light 1	Light 1	Light 1
LED 4	Heat On	Heat On	Heat On

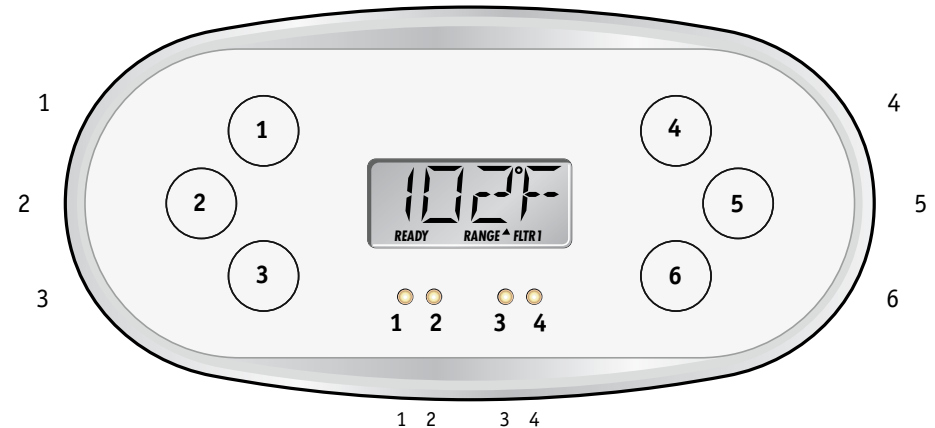

Setups 2, 3, 5, 6, 8 & 9 can use an overlay such as 12762:



Setups 1, 4 & 7 require a different overlay, such as 13579:



Manufactured under one or more of these patents. U.S. Patents: 5332944, 5361215, 5550753, 5559720, 5,883,459, 6253227, 6282370, 6590188, 6976052, 6965815, 7030343, 7,417,834 b2, Canadian Patent: 2342614, Australian patent: 2373248 other patents both foreign and domestic applied for and pending. © Copyright 2014 Balboa Water Group.

BP6013 Configuration Options

Auxiliary Panel Features on Bank 1*

Feature	Default
Aux Button A1	Jets 1
Aux Button A2	Jets 2
Aux Button A3	Jets 3 in Setups 2, 5 & 8 Blower in other Setups
Aux Button A4	Light

*Bank 1 consists of J5 on the Main Circuit Board.
Aux Connection Splitter PN 25257 may be required.

Buttons that are assigned to equipment that is not defined in a Setup will not do anything in that Setup.

BP6013 Configuration Options

Auxiliary Panel Features

AX10 Panels on Bank 1*

A1, AX10A1	No O/L	52803
A2, AX10A2	No O/L	52804
A3, AX10A3	No O/L	52805
A4, AX10A4	No O/L	52806

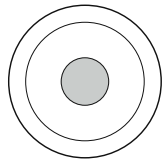

Call Customer Service for additional information about Auxiliary Panels.

*Bank 1 consists of J5 on the Main Circuit Board.
Aux Connection Splitter PN 25257 may be required.

AX20

AX20 A1A2	No O/L	52800
AX20 A1A3	No O/L	52801
AX20 A1A4	No O/L	52802

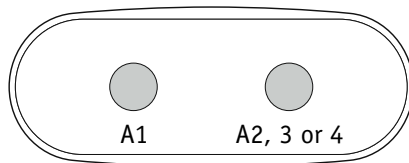

AX20 Auxiliary Panel plugged into Bank 1 will operate A1 + A2, A3 or A4.

AX40

AX40	No O/L	52799
------	--------	-------

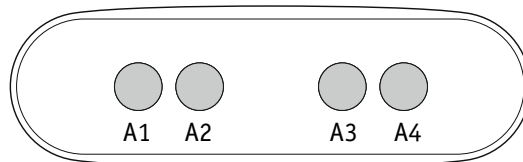

AX40 Auxiliary Panel plugged into Bank 1 will operate A1 + A2, A3 and A4.